

DIGITAL ALARMS FOR HOSPITALS AND LABORATORIES

INSTALLATION AND OPERATING INSTRUCTIONS

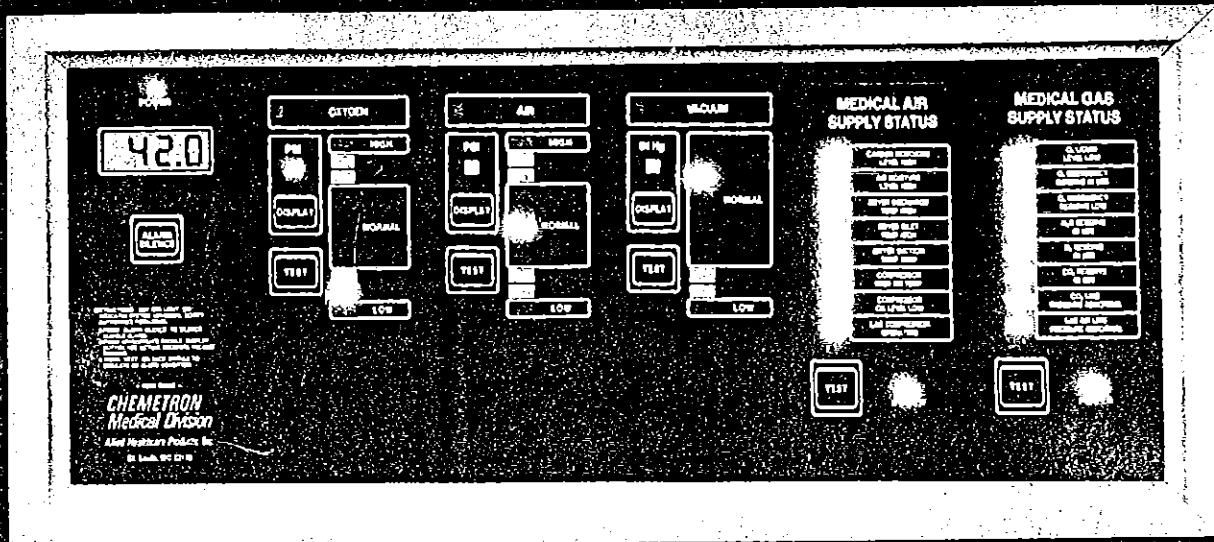

Introduction

Allied Healthcare Products, Chemetron Medical Division Digital Alarms are designed to monitor the supply status of piped medical gases, including clinical vacuum, and the respective delivery pressures of each gas or vacuum. Observe the following guide when designing or installing a specific medical gas alarm wiring system.

OBSOLETE

Table of Contents

Description of Components	3-4
Theory of Operations	5
Installation	6-7-8-9
Field Calibration For Digital Alarms	10
Typical Wiring Schematic	11-12-13-14
Typical Wall Box	11
Replacement Parts For Digital Alarms	15

Description of Components

The following description of components has been included to familiarize you with the terminology used in this manual.

A. The Back Box

1. The Back box (See Fig. 1) contains the electronic "mother board," step-down transformers for the internal low voltage control circuitry, and all necessary connectors to accept the various modules described below.

CAUTION: protect the internal components within the back box by keeping the dust cover in place until the modules are ready to be installed.

2. Two types of back boxes exist:
 - a. One contains (See Fig. 1) copper pigtailed to which an installer directly connects gas or vacuum.
 - b. One (not pictured) does not contain pigtailed. This back box is designed to incorporate only the eight-annunciator module which accepts electrical signal inputs.

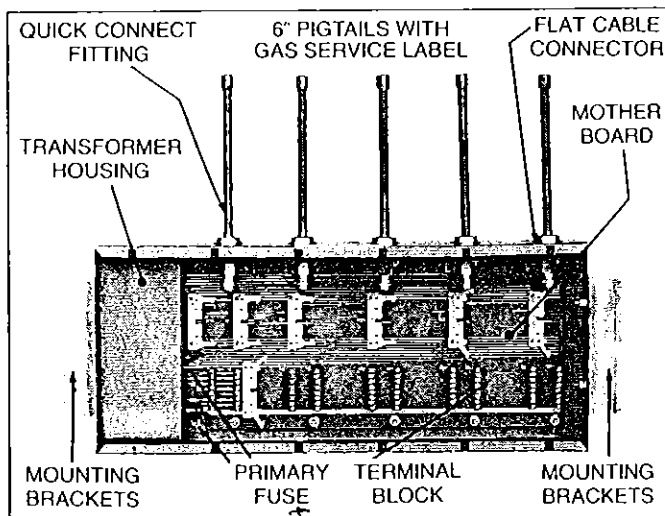

FIG. 1 — BACK BOX WITH PIGTAILS

B. The Display Module

There are two types of Display Modules. (See Fig. 2). Both contain the power-on indicator and the audio alarm silencer button. A Liquid Crystal Display (LCD) differentiates the two modules. The LCD module is used only with the back box containing copper pigtailed. The non-LCD module is used exclusively with the back box that does not contain copper pigtailed.

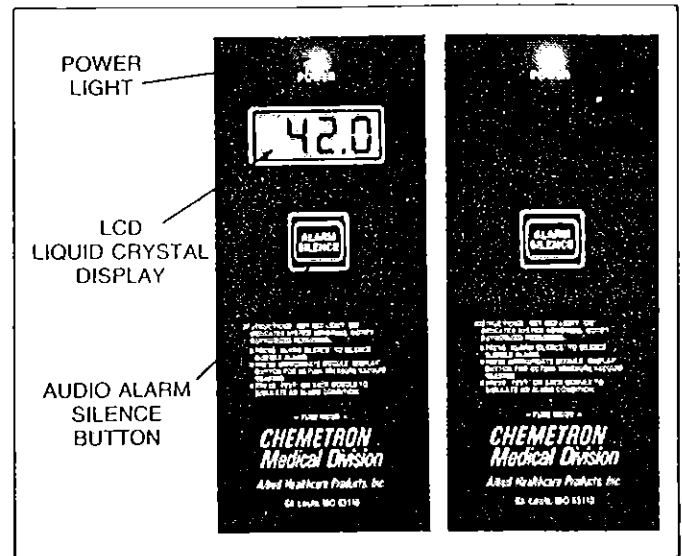

FIG. 2 — LCD AND NON LCD DISPLAY MODULES

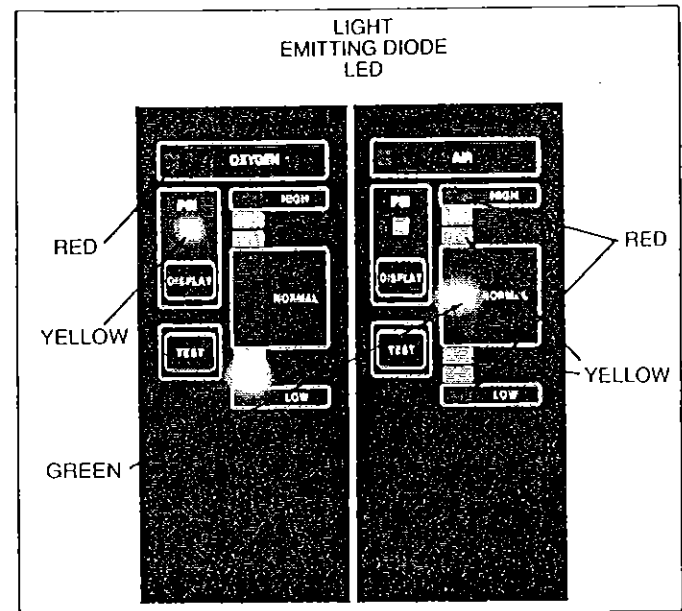

FIG. 3 — PRESSURE MODULE

C. The Line Pressure Module

There are two types of line pressure modules — for pressure gases (See Fig. 3) and vacuum. (See Fig. 4) All pressure gases utilize the line pressure module containing both high and low limits. The line pressure module for vacuum contains only a low limit. Both types of line pressure modules contain a vertical display consisting of light emitting diodes (LED), a test button, a display button to activate the LCD module, a yellow indicator light near the display button to signify which module is in display and a red indicator light to signify an alarm state.

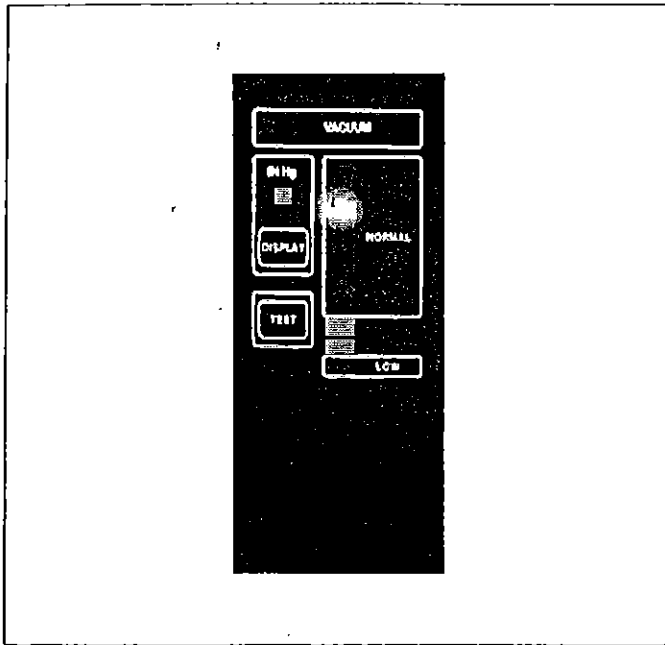

FIG. 4 — VACUUM MODULE

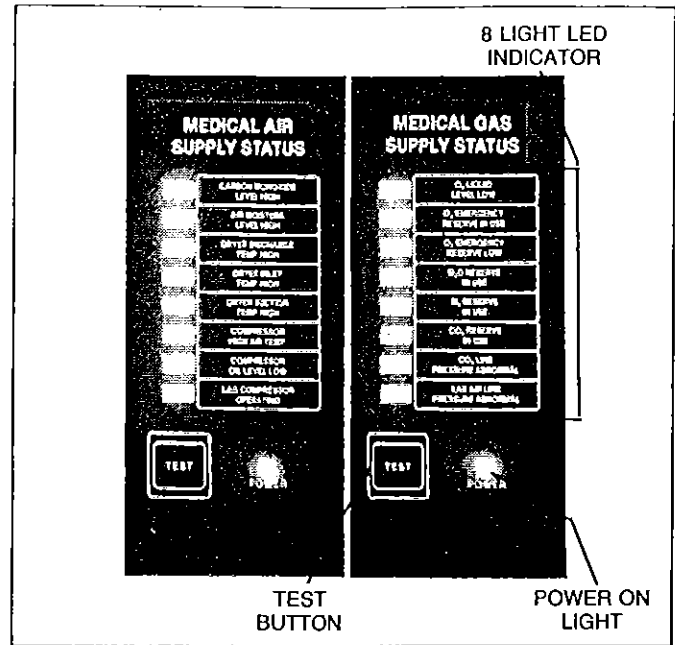

FIG. 5 — 8-SIGNAL MODULE

D. The 8-Signal Module (See Fig. 5)

The 8-Signal Module consists of eight LED indicator positions which are used to monitor remote signal inputs. Example — Reserve in use, low liquid oxygen level, high and low line pressures, low vacuum, etc. The module contains a power ON indicator and a test button.

E. The Blank Module

Blank Modules are provided in certain configurations because the back box employed contains positions that are unused or for future use.

Theory of Operation

A. Line Pressure Module

1. The *Line Pressure Module* (See Fig. 3) contains an eleven step bar of LED's that is calibrated to display pressure or vacuum in the range to be monitored. Light will move up and down the LED as the pressure being monitored increases or decreases. During normal operation the LED will remain in the green "normal" area. As the pressure changes toward an alarm condition the light will change from green to yellow and ultimately to the red "alarm" condition. The alarm condition signifies a $\pm 20\%$ variation in the line pressure, or -20% for vacuum.
2. Alarm State — When an alarm condition occurs, a RED LIGHT beside the name of the gas will turn on, the audio circuit will energize signalling a fault, and the LCD module will exhibit the gas or vacuum pressure in its window.
3. When a pressure value is being displayed on the LCD, the module *in display* will have the YELLOW LIGHT turned on above the display button signifying this module is *in display*. The display feature is shared with the other modules and, therefore, only one module can be in display at any given moment. The yellow light above the display button will always indicate the current module being displayed on the LCD.
4. Alarm Silence (See Fig. 2) — When in an alarm condition, the button on the display module will cancel the audio alarm tone and the red light beside the gas or vacuum name. Note that the vertical LED will remain in the red alarm position until the fault is corrected. As long as no other module is in the *alarm*, *display*, or *test* mode, the module *in alarm* will remain in the LCD display. The alarm condition causes the display to be "commanded" for that module without the operator having to press the display button. If two or more alarms have occurred, the yellow light will move from module to module displaying each service that is in alarm. This is done on a timed sequence in which the modules in alarm condition will alternately be in display.
5. Multiple Alarm Conditions — Silencing the initial fault will NOT affect the red light beside the gas service or the audio signal from activating with any subsequent alarm condition from other modules.
6. Display & Timed Sequence — Pushing the display button (See Fig. 3) when another module is in *alarm* or *test* will NOT cause the module commanded to go into a display mode until the test function or alarm condition has timed out on the internal circuitry. It is normal to wait a few seconds for the requested module to come into display.

7. Test — The test function is provided on each module to exercise the electronic circuitry that monitors the gas or vacuum pressure. It further tests all LED, LCD, and audio functions of the alarm module. Pressing the test button (See Fig. 3) will cause a simulated failure to take place. The LED will initially move up or down, but not both. If the test cycle initially displayed a high alarm condition, depress the test button after the unit has returned to normal in order to test the low function.

As the LED moves upward or downward in the vertical display, the yellow light signifying *in display* and the LCD value will come on when the red LED light is reached.

The increasing or decreasing pressure values will be displayed on the LCD. When the pressure reaches the high or low limit (red LED) the audio tone will commence and the red light beside the name of the gas service will come on. At this time the alarm silence function can be tested. **REMINDER:** once a module has been started on the test procedure, pressing *display* on subsequent modules will put them in cue to display after the initial test has timed out.

B. The 8-Signal Module

The 8-Signal Module (See Fig. 5) is used exclusively to monitor remote signals. Examples of such remote signals are: *Reserve In Use*, *Low Liquid Oxygen Level*, *High/Low Abnormal Line Pressure*, or the status of another alarm panel which is wired in *slave*. The 8-Signal Module contains a GREEN power ON indicator and a test button that will activate all eight signals simultaneously and the audio tone in the display module. In operation, one or more of the red lights coming on will cause an audible alarm from the display module and activate the red light beside the appropriate signal description. Pressing the silence button on the display module will not cause the red visual indicator to go out. Only a correction at the source of the signal will cause the red indicator light to turn off. Each of the signals in the 8-Signal Module acts independently of the others during an alarm condition; i.e., activation of any other signal in any sequence of the remaining seven signals will duplicate the alarm functions independently.

C. The Display Module

The display module (See Fig. 2) contains the power ON indicator light for the entire system. Pushing the alarm silence button will cancel the audio signal input received from any other module. The audio speaker is contained behind the display module.

Installation

A. Mounting Box Installation

1. Remove the back box from carton and store carton (with modules and frame) in a safe, dry place until all plastering and wiring is completed.

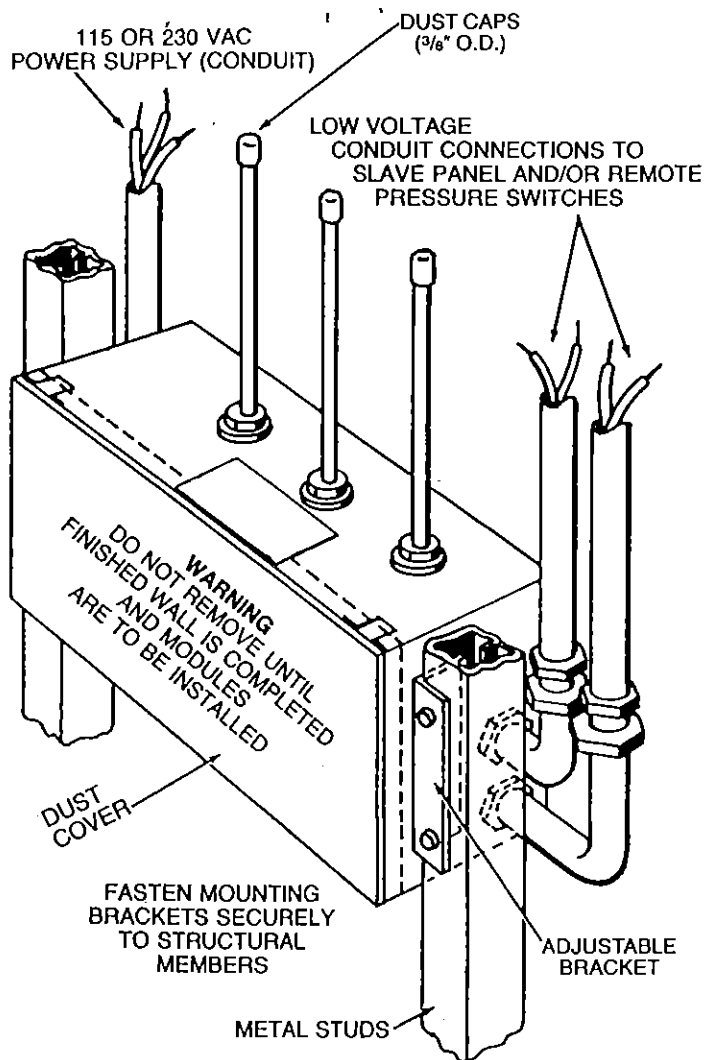

FIG. 6 — BOX INSTALLED IN WALL

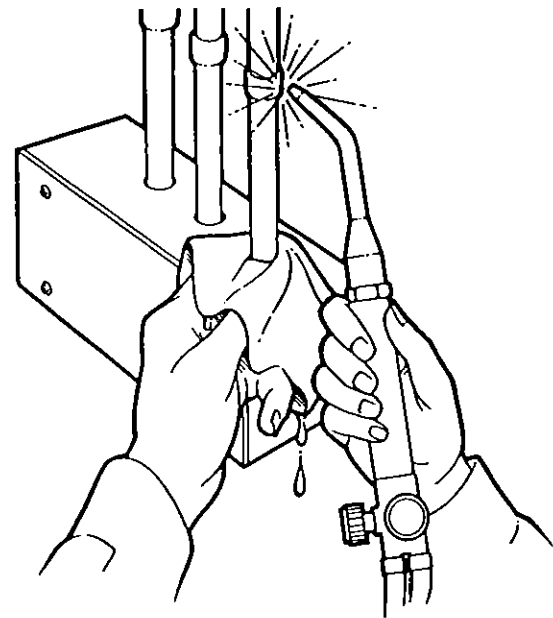

FIG. 7 — MINIMIZE OVERHEATING OF VALVE

2. Install the back box at the specified height in a roughed-in wall. (See Fig. 7) Fasten it securely to the metal framing. Note the finished wall line label and *make sure the box is flush with the finished wall surface*. Contractor is reminded to co-ordinate with other trades in anchoring alarms rigidly into the wall. It is not sufficient to simply grout them in. **NOTE: Finished wall line must be exactly defined.** The mounting brackets are adjustable. Loosen nuts from inside the box. (**CAUTION: Nuts are not captured. Do not back off.**) Sides of box must be adjusted out from the wall to allow clearance for the frame/window assy.
3. Remove dust caps to connect line pressure sensing tubes to appropriate 3/8" O.D. (1/4" NOM) laterals.
4. As the connections are being made, identify each line (both inside the box and on the standpipes outside the box) using the self-adhesive labels supplied. Be careful not to damage the check valve (by overheating the lower portion) while silver-brazing. Wrap the pigtail with a damp cloth or use a commercially available heat sink to minimize over-heating (See Fig. 9).

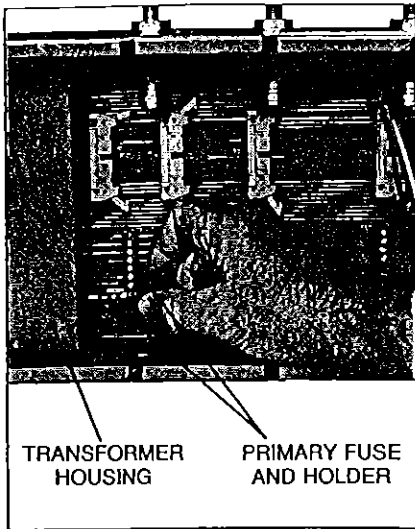

FIG. 8A — FUSE AREA

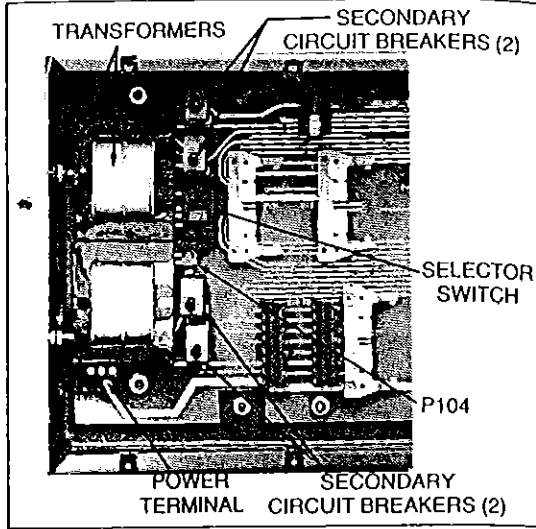

FIG. 8B — COVER OFF TRANSFORMER

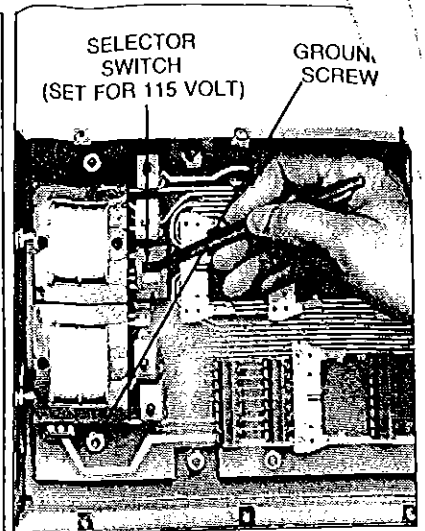

FIG. 8C — SETTING SELECTOR SWITCH

5. Replace the dust cover until it is time to pressure test the system.

CAUTION: A pressure test must be performed without transducer in place in order to prevent damage to the transducer.

B. Wiring

1. Remove the transformer housing. The primary fuse and fuse holder should be taped to the housing. If not remove primary fuse and do not install until all modules are installed (See Fig. 8A). Bring 115 or 230 volts AC to the left side of the back box (See Fig. 8B) and connect conductors to points 1 and 3 of terminal strip TB101 and ground wire to grounding post. Electrical supply should be from the standard and essential electrical system, life safety branch. Verify that the selector switch is set for proper voltage (See Fig. 8C).

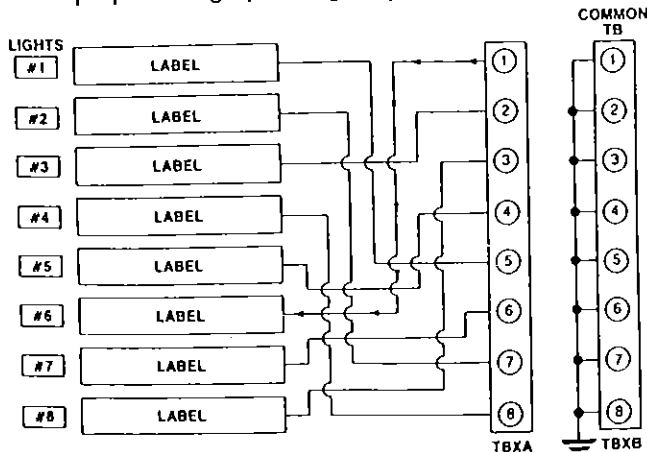

FIG. 9 — WIRING SEQUENCE

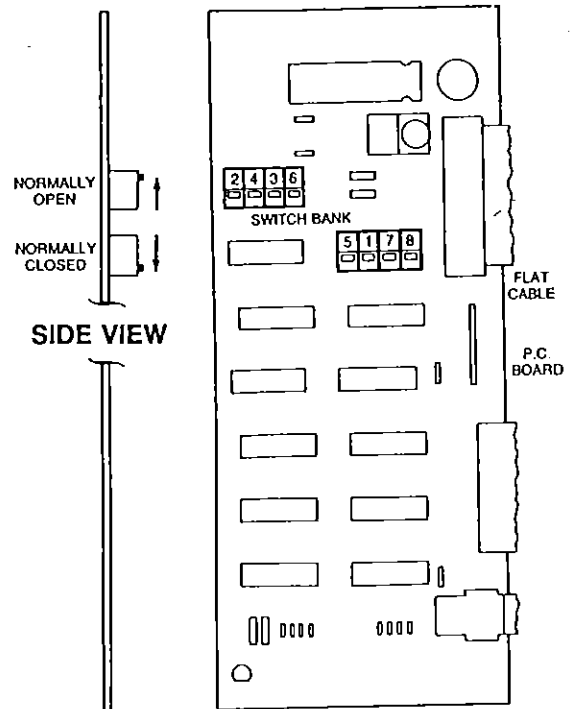

FIG. 10 — SWITCHES WITH CORRESPONDING NUMBERS

2. Connect the primary fuse clip to the terminal plug P104 (See Fig. 8B) on the mother board. Replace the transformer housing and primary fuse.
3. Signal and DC leads are run to remote switches and slave panels from the bottom or right side of the cabinet. Unless otherwise specified, all signal wiring shall be #18 gauge insulated wire.

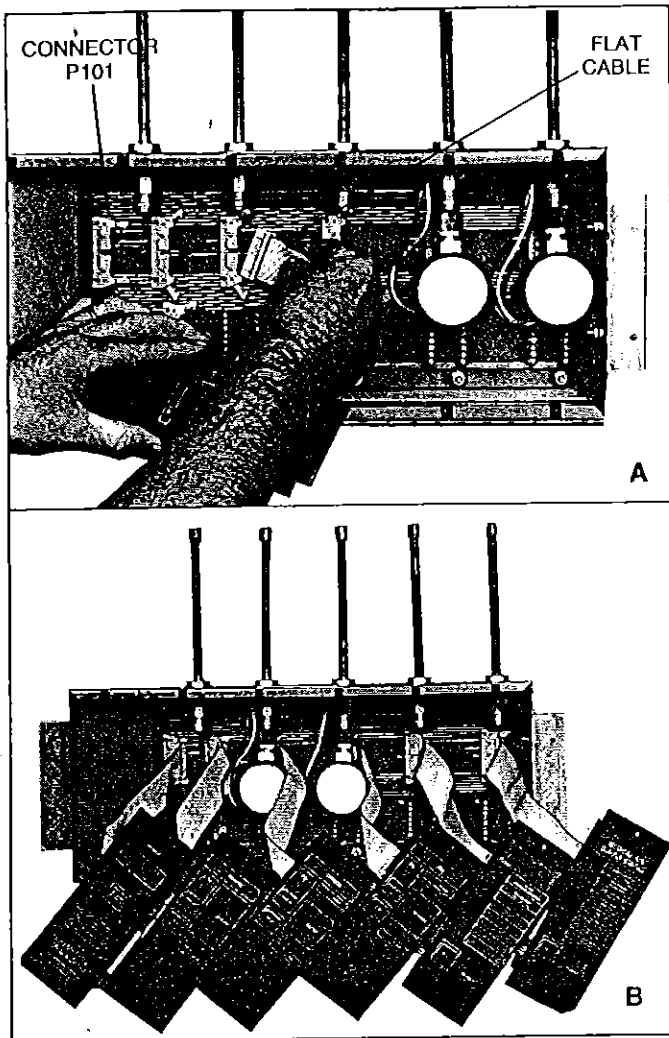

FIG. 11 — FLAT CABLE CONNECTION TO PC BOARD

The maximum wire size for use with this system is 14 gauge. Use Belden multi-wire cables or equivalent for five or more:

Belden Cable #8465 — 5 wire	#8466 — 12 wire
#8467 — 7 wire	#8468 — 15 wire
#8469 — 9 wire	

4. Knockouts are provided for making conduit connections to the box. The maximum recommended wire length to any remote switch is 1500 feet. Distances greater than 1500 feet may require special design consideration. Contact your local Allied Healthcare Products, Chemetron Medical Division representative. All wiring should be installed according to local codes.

5. Wiring The 8-Signal Module

- a. After pulling remote signal wires to the alarm panel, make connections to the appropriate terminals (TBXA) as identified (See Fig. 9). For example, signal position No. 6 ("Lights") on the module is connected to terminal strip TBXA, position No. 1 and common wire is connected to the corresponding No. 1 on the TBXB terminal strip.

- b. The 8-Signal Module may be set up for use with normally open (N.O.) or normally closed (N.C.) remote switches. On the back of each 8-Signal Module are eight switches (See Fig. 10) for switch and signal position identification. To set for N.O. the switch will be set in the up position (See Fig. 10). To set for N.C. the switch will be set in the down position.

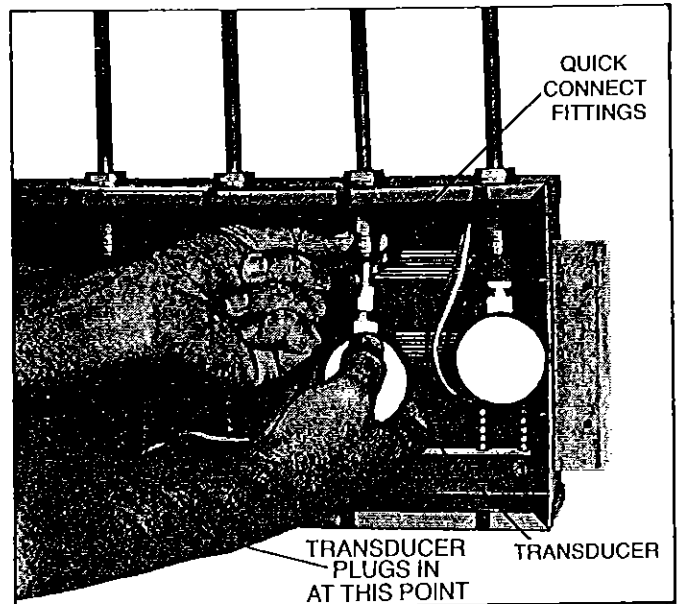

FIG. 12 — INSTALLING TRANSDUCER

C. Plug-In Module Installation

CAUTION: Primary fuse must be out of holder. If it is not serious damage can occur to the modules.

1. Remove the protective dust cover and unwrap the plug-in modules.

NOTE: If any module is the 8-signal type, all external switch wiring and identification of remote switches as normally open or normally closed type must be complete before continuing.

2. Install the display module (the one with a silence button) on the left side of the back box over the transformer. Plug in the flat cable connector to the PC board at connection P101 (See Fig. 11A). Be sure to unlock the connector by pressing out on locking tabs before inserting the plug. After the cable connector is in place, depress both locking tabs to secure the connector into place.

3. Install the next module working from left to right matching the identified gas supply and terminal wiring to the module that you are installing. Connect the flat cable connector to the proper terminal.
4. After installing the cable connector and locking it into position, the module may be allowed to hang by the ribbon cable until all subsequent modules have been connected (See Fig. 11B).

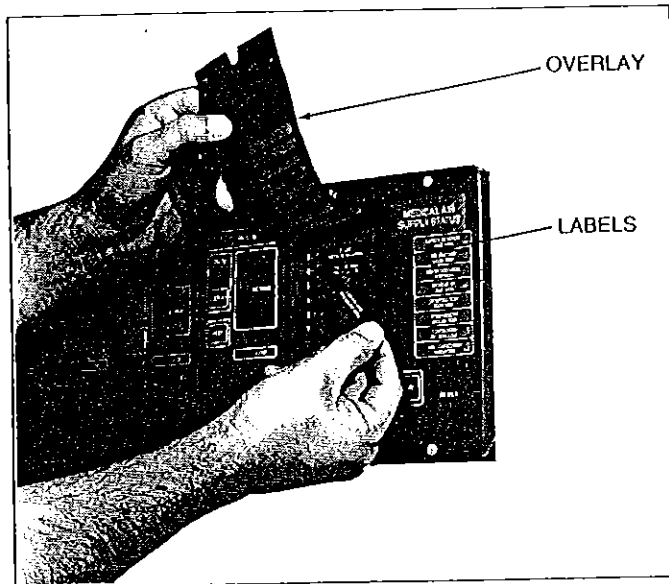

FIG. 13 — LABELING THE MODULES

D. Pressure Transducer Installation

NOTE: Each pressure or vacuum transducer has been calibrated at the factory to a standard traceable to NBS, and contains a serial number corresponding to the module for which it has been calibrated. Verify these serial numbers before proceeding.

1. Holding the snap-on wire connector from the transducer, connect the transducer in module position No. 1 (next to the display module) to the PC board at P1B (See Fig. 11).
2. Install the pressure or vacuum transducer by pushing up on the brass coupler sleeve and inserting the male connector on the gauge (See Fig. 12.) Repeat steps 1 and 2 for all remaining transducers.

CAUTION: Test that the transducer is in place by pulling downward on the transducer and pulling downward on the locking sleeve of the brass coupler.

3. Install primary fuse and continue.

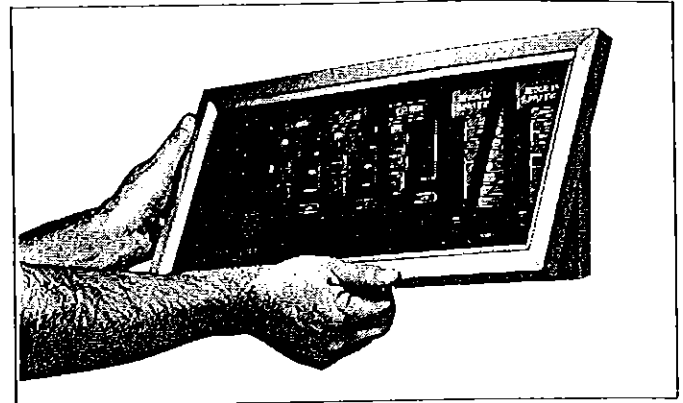

FIG. 14 — INSTALLING FRAME

E. Labeling The Modules

1. Verify that the gas service labeling on each module corresponds to the gas service identified with the back box.
2. The overlay for each module adheres only at the top and may be lifted to apply gas service identification labels, PSI or mm Hg labels behind the view windows for each module (See Fig. 13). The 8-Signal Module is similarly labeled with the pre-printed, self-adhesive labels provided. Double sided tape is provided at the bottom of the module. The installer is to remove the protective cover then press down overlay.

F. Finishing Assembly

Each module is fastened to the back box using the Phillips flathead screws provided. Once the modules are in position, the finishing frame may be installed.

Hold the sides of the frame, place the frame on the top edge of the back box and swing the bottom edge into position (See Fig. 14). Detents located on the frame will snap into position as the frame is pushed in at the bottom. We recommend applying pressure at the lower corners of the frame.

G. Calibration and Service

Contact the Allied Healthcare Products, Chemetron Medical Division service department for calibration and service instructions for the Digital Alarm System at 800-543-6436.

NOTE: DISPLAY ACCURACY

FIELD CALIBRATION FOR DIGITAL ALARMS

CAUTION: The Alarm Modules should Never be installed or removed with the Power ON.

- 1) Disassemble the Alarm, as in Figure 11B to allow easy access to the adjustments on the back of each module.
- 2) Turn on the power to the Alarm Panel and allow the modules to go through their test cycle.
- 3) Zero Adjustments and Line Pressure Adjustments.
 - A) Remove the transducer associated with the module being calibrated (See Fig. 12) so that the Digital Display reads zero. The electrical connector of the transducer must stay in place.
 - B) Press the "Display" button of the module under test. The Display Module will indicate the pressure of this module.
 - C) If the Display Module does not indicate Zero ($\pm .5$) then R33 of the module under test must be adjusted (See Fig. 15) until the Display Module indicates zero.
 - D) Since the transducer does not have a gauge to compare the display to, we suggest the use of our "Alarm-Digital Gauge Model Calibration Kit" (P/N 74-90-0109) to reference to. Plug the transducer into the calibration kit, then plug the calibration kit into the fitting that the transducer will go into. Then press the "Display" button. The pressure on the calibration kit gauge should be on the LCD display. If the reading is incorrect, adjust R32 until the display agrees with the gauge reading.

NOTE: Each module must be calibrated to a transducer with an identical serial number.

- E) Repeat A through D to verify proper calibration. Each adjustment of the zero setting will effect the upper pressure reading setting and each adjustment of the upper pressure setting will have an effect on the zero setting. Each time an adjustment is made the effect is less.

ALARM SET POINTS (SEE FIG. 15)

- 1) To set the alarm points on an individual module, the module must be in the "Simulation Mode." To put a module in the "Simulation Mode," Switch #1 must be in the *Up* position (See Figure 15C).
 - 2) Push "Alarm Display" on module to be calibrated. Adjust R34 until the digital readout indicates the desired high alarm setting (e.g. O₂ at 65 PSI). Adjust R30 until the audio alarm is activated and the red L.E.D. zone on high alarm is illuminated (for pressure gas modules only). To check high alarm set point, readjust R34 to lower simulated pressure and increase again to confirm that the digital high alarm set point (e.g. 65 PSI) coincides with the red L.E.D. and audio alarm.
- Perform the similar adjustment for the low alarm set point using R31 instead of R30 for the visual and audio alarm adjustment.
- 3) Reset Switch # 1 to the *Down* position.
 - 4) The module is now ready for operation.

FIG. 15 — CALIBRATION SELECTOR SWITCH FUNCTIONS

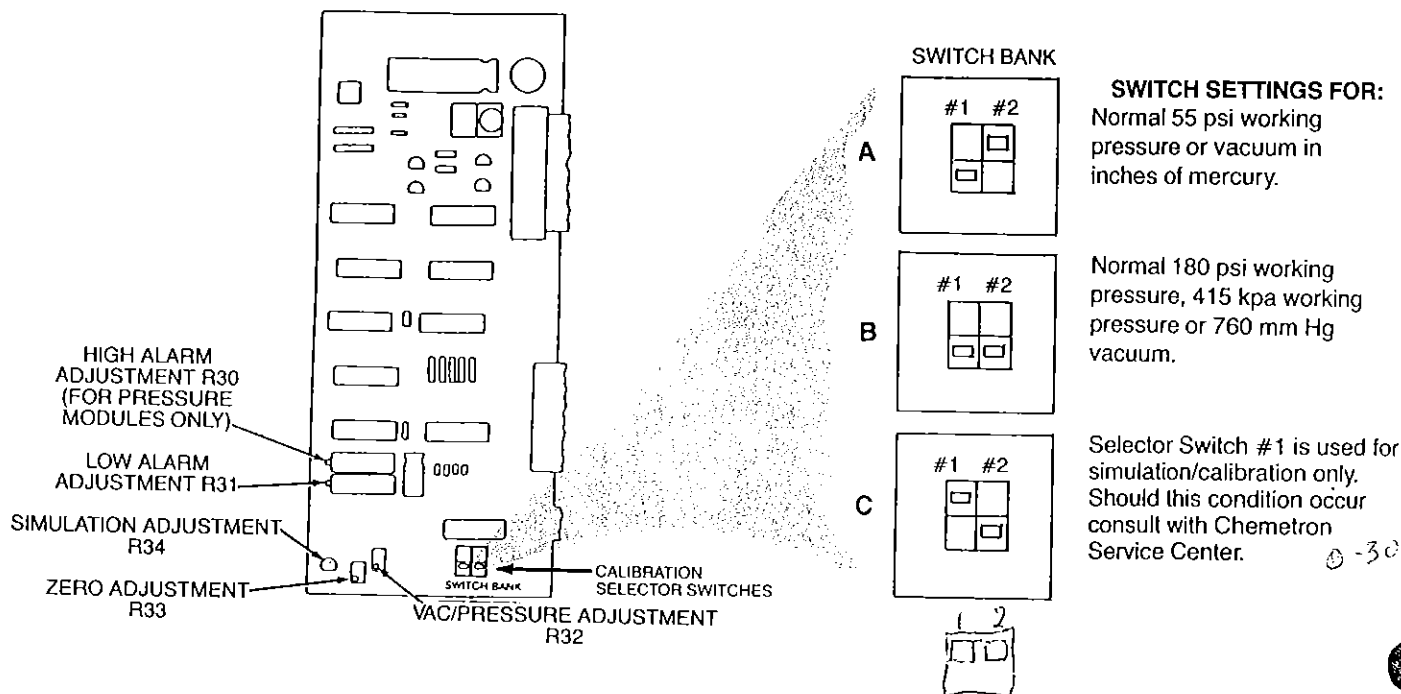

Typical Wiring Schematic

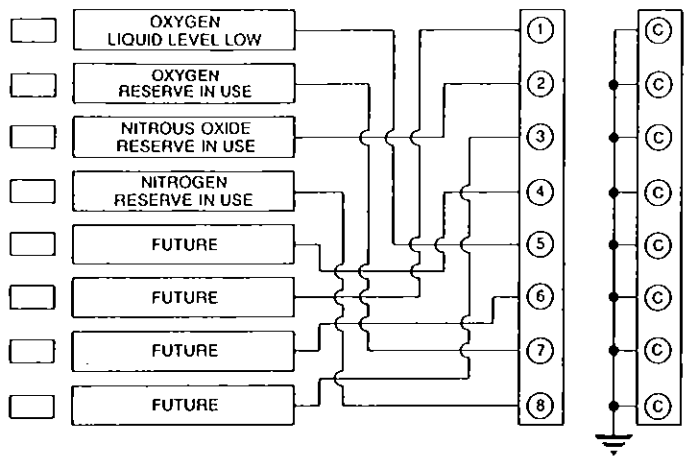

Master Alarm Location of 8 Signal Modules

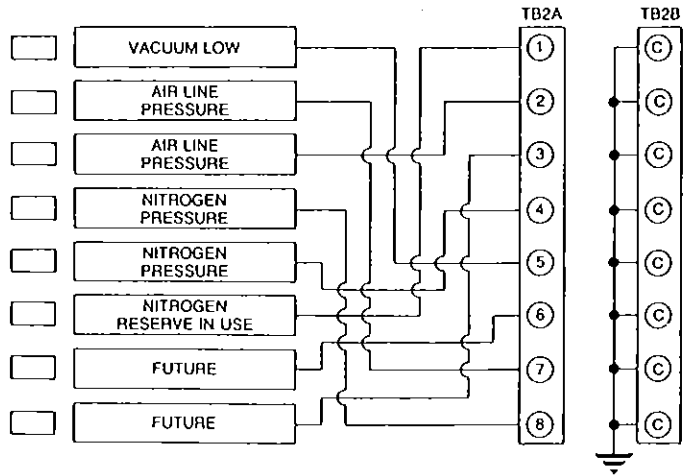

8 Signal Modules Slave Location

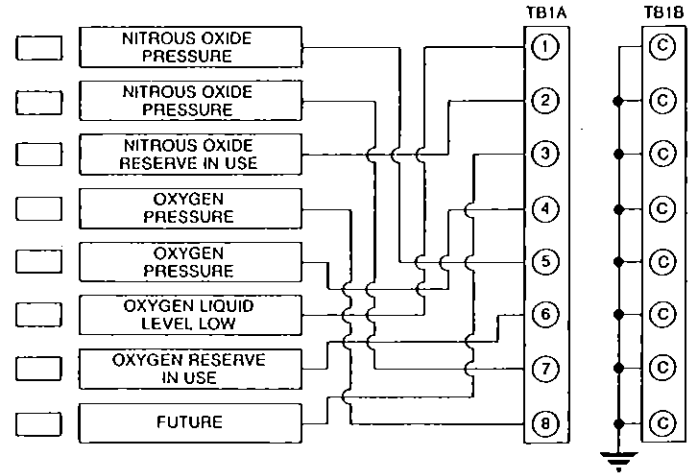

8 Signal Modules Slave Location

FIG. 18 — TYPICAL WIRING DIAGRAMS FOR EIGHT SIGNAL MODULES

Typical Wiring Schematic

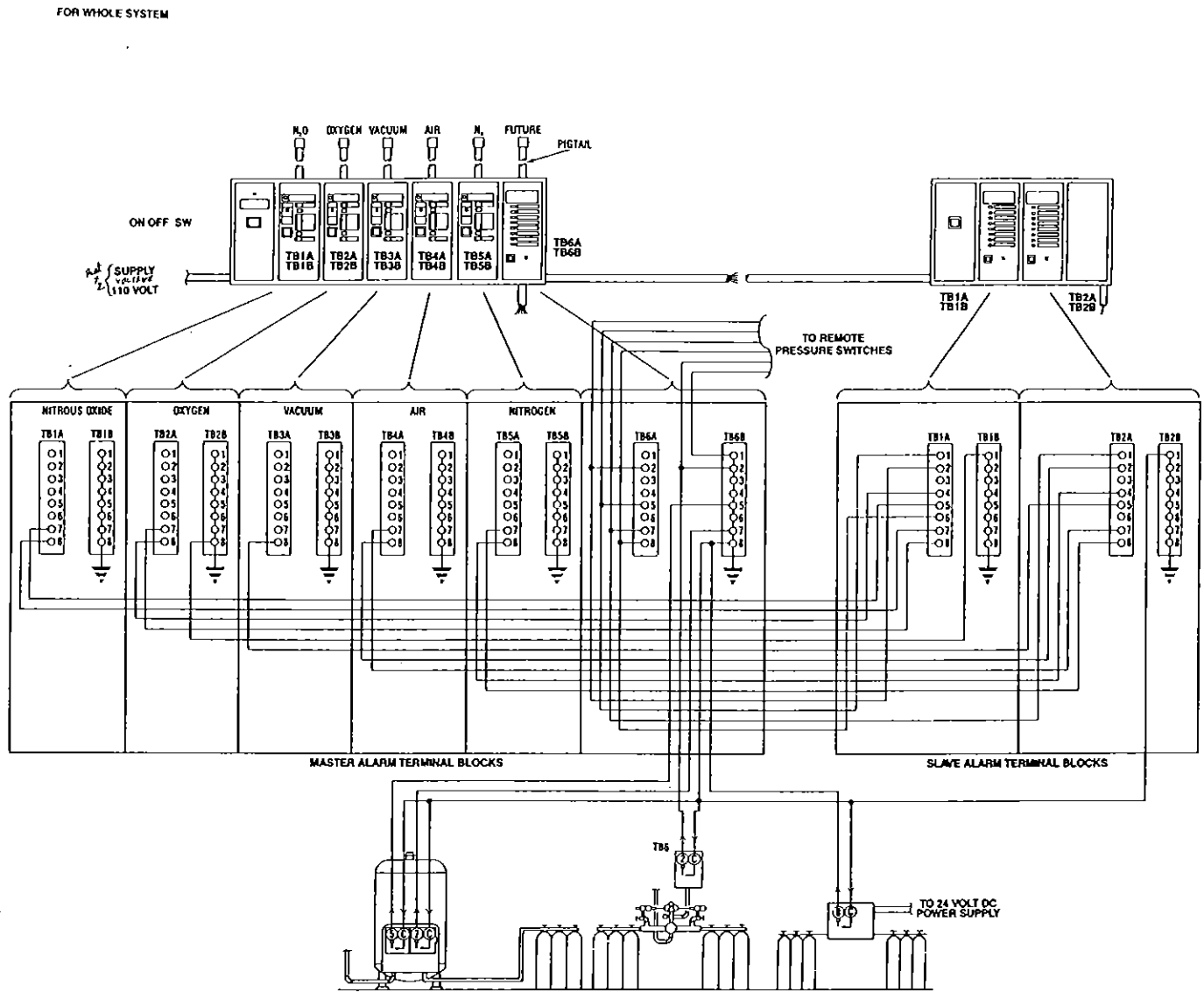

FIG. 19 — TYPICAL WIRING DIAGRAM FOR MASTER ALARM WITH INTERNAL PRESSURE ALARM INDICATORS

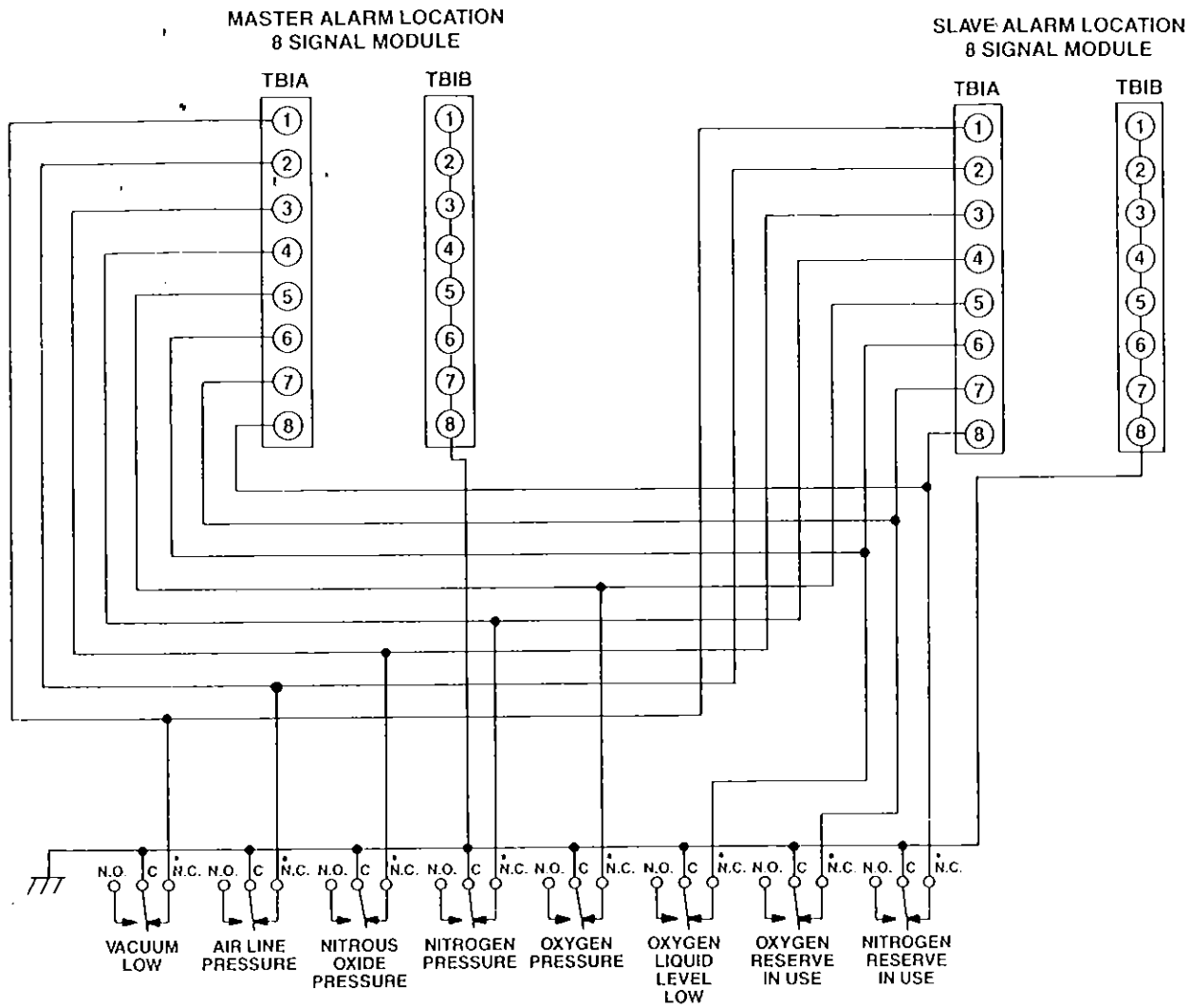

FIG. 20 — TYPICAL WIRING DIAGRAM FOR MASTER AND SLAVE 8 SIGNAL MODULES

NOTE: MASTER AND SLAVE ARE WIRED IN PARALLEL. THE PREFERRED LOCATION OF THE TIE-POINT IS THE SWITCH BEING MONITORED.

ALARM-DIGITAL GAUGE MODEL CALIBRATION KIT

*Allied Healthcare
Products, Inc.*

CHEMETRON Medical Division

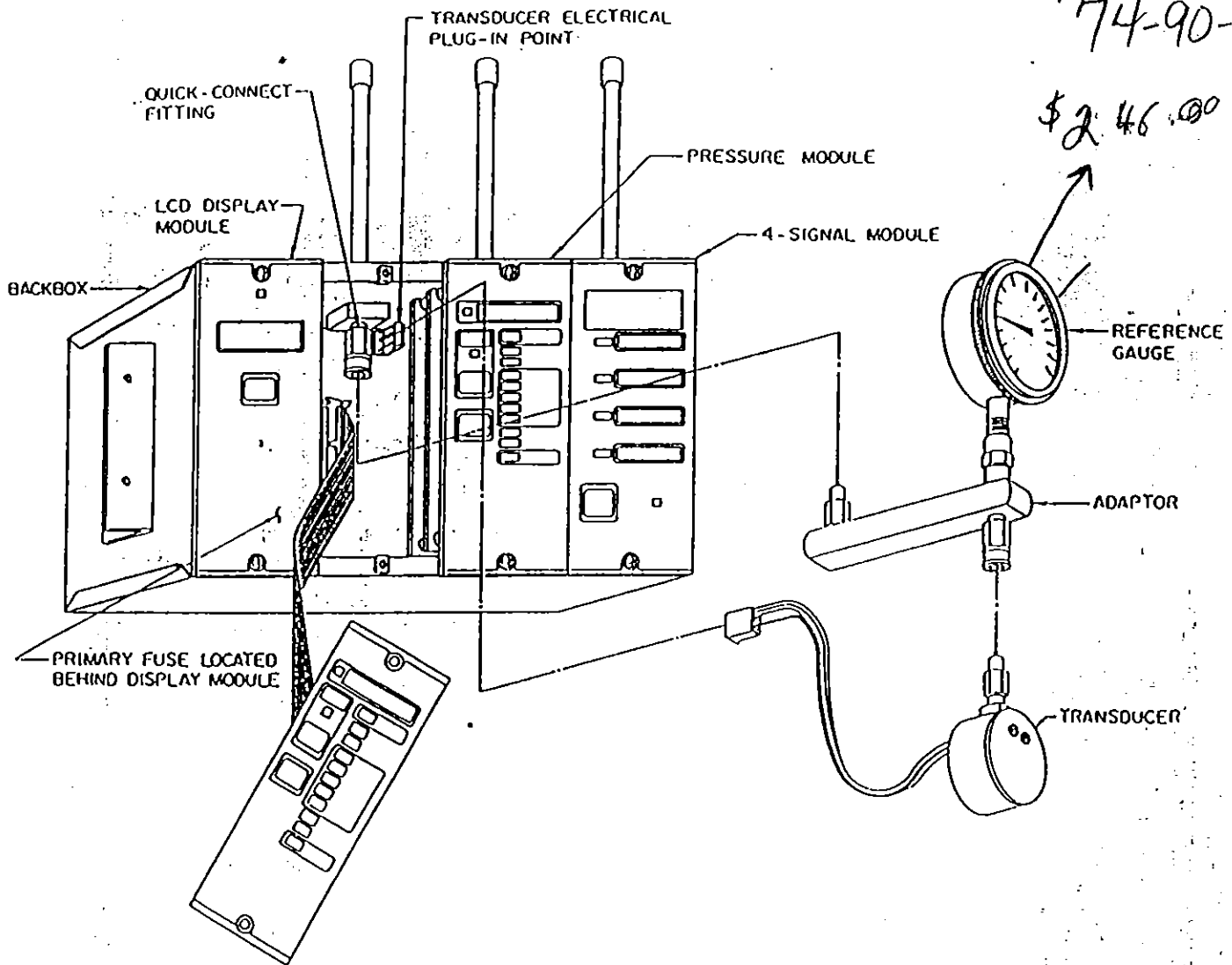

FIG.1--SETTING UP FOR FIELD CALIBRATION

REPLACEMENT PARTS FOR DIGITAL ALARMS

All Repair Parts listed are field replaceable.

NOTE: Parts not identified as field replaceable are not considered to be such and in the event of malfunction or breakdown of one of these parts, the entire assembly should be replaced or returned to our factory.

Contact our Factory Service Center if you have any questions 1-800-444-3954.

FACTORY AVAILABLE REPLACEMENT PARTS

- | | |
|--|--|
| 74-90-0100 6" Copper Pigtail w/Socket (Fig. #1) | *74-90-0119 Secondary Solder-in Fuses .75 Amp |
| 74-90-0102 Vacuum/Bargraph Module w/Transducer (Fig. #11B) | 75-90-0120 Main Power Fuse .20 Amp (Fig. #3) |
| 74-90-0103 100 psi Pressure/Bargraph Module w/Transducer (Fig. #11B) | 74-90-0121 Fuseholder HKP type (Fig. #8A) |
| 74-90-0104 300 psi Pressure/Bargraph Module w/Transducer (Fig. #11B) | 74-90-0122 U-Clip Fasteners |
| 74-90-0105 8 Remote Signal Annunciator Module (Fig. #11B) | 74-90-0123 4 Gang Finish Trim (Fig. #14) |
| 74-90-0106 BLANK INSERT (FUTURE) | 74-90-0124 6 Gang Finish Trim (Fig. #14) |
| 74-90-0107 Non Display Power Module (Fig. #11B) | 74-90-0125 7 Gang Finish Trim (Fig. #14) |
| 74-90-0108 Digital Display Power Module (Fig. #11B) | 74-90-0130 Pressure Sensitive ID Labels (Fig. #13) |
| 74-90-0109 Gauge Model, Digital Alarm Calibration Kit | 74-90-0131 Overlay for Non-Display Power Module (Fig. #16) |
| 74-90-0110 7 Module Mother Board w/Transformers (Fig. #1) | 74-90-0132 Overlay for Display Power Module (Fig. #16) |
| 74-90-0111 6 Module Mother Board w/Transformers (Fig. #1) | 74-90-0133 Overlay for VAC Module (Fig. #16) |
| 74-90-0112 4 Module Mother Board w/Transformers (Fig. #1) | 74-90-0134 Overlay for Pressure Module (Fig. #16) |
| | 74-90-0135 Overlay for 8 Signal Module (Fig. #16) |
| | 74-90-0136 Overlay for BLANK (Fig. #16) |
| | 74-90-0140 Assorted Pack-Face Plates |

*Newer units have circuit breakers instead of fuse. They are not interchangeable.

REPLACEMENT PARTS FOR DIGITAL ALARMS

All Repair Parts listed are field replaceable.

NOTE: Parts not identified as field replaceable are not considered to be such and in the event of malfunction or breakdown of one of these parts, the entire assembly should be replaced or returned to our factory.

Contact our Factory Service Center if you have any questions 1-800-444-3954.

FACTORY AVAILABLE REPLACEMENT PARTS

74-90-0100	6" COPPER PIGTAIL WITH SOCKET	(FIG. 1)
74-90-0206	VACUUM MODULE WITH TRANSDUCER	(FIG. 14)
74-90-0203	100 PSI PRESSURE MODULE WITH TRANSDUCER	(FIG. 14)
74-90-0204	300 PSI PRESSURE MODULE WITH TRANSDUCER	(FIG. 14)
74-90-0105	8 REMOTE SIGNAL MODULE	(FIG. 5)
74-90-0205	4 REMOTE SIGNAL MODULE	(FIG. 5)
74-90-0106	BLANK INSERT	(FUTURE)
74-90-0107	NON-DISPLAY MODULE	(FIG. 2)
74-90-0108	DIGITAL DISPLAY MODULE	(FIG. 2)
74-90-0109	GAUGE MODEL, DIGITAL ALARM CALIBRATION KIT	
74-90-0110	7 MODULE MOTHER BOARD WITH TRANSFORMERS	(FIG. 1)
74-90-0111	6 MODULE MOTHER BOARD WITH TRANSFORMERS	(FIG. 1)
74-90-0112	4 MODULE MOTHER BOARD WITH TRANSFORMERS	(FIG. 1)
*74-90-0119	SECONDARY SOLDER-IN FUSES .75 AMP	
74-90-0201	SECONDARY CIRCUIT BREAKERS .75 AMP	
74-90-0120	MAIN POWER FUSE .20 AMP	(FIG. 9)
74-90-0122	U-CLIP FASTENERS	
74-90-0123	4 GANG FINISH TRIM	(FIG. 15)
74-90-0124	6 GANG FINISH TRIM	(FIG. 15)
74-90-0125	7 GANG FINISH TRIM	(FIG. 15)
74-90-0130	PRESSURE SENSITIVE ID LABELS	(FIG. 15)
74-90-0131	OVERLAY FOR NON-DISPLAY MODULE	(FIG. 15)
74-90-0132	OVERLAY FOR DISPLAY MODULE	(FIG. 15)
74-90-0133	OVERLAY FOR VACUUM MODULE	(FIG. 15)
74-90-0134	OVERLAY FOR PRESSURE MODULE	(FIG. 15)
74-90-0135	OVERLAY FOR 8-SIGNAL MODULE	(FIG. 15)
74-90-0202	OVERLAY FOR 4-SIGNAL MODULE	(FIG. 15)
74-90-0136	OVERLAY FOR BLANK	(FIG. 15)
74-90-0140	ASSORTED PACK-FACE PLATES	

*Newer units have circuit breakers instead of fuses. They are not interchangeable.